

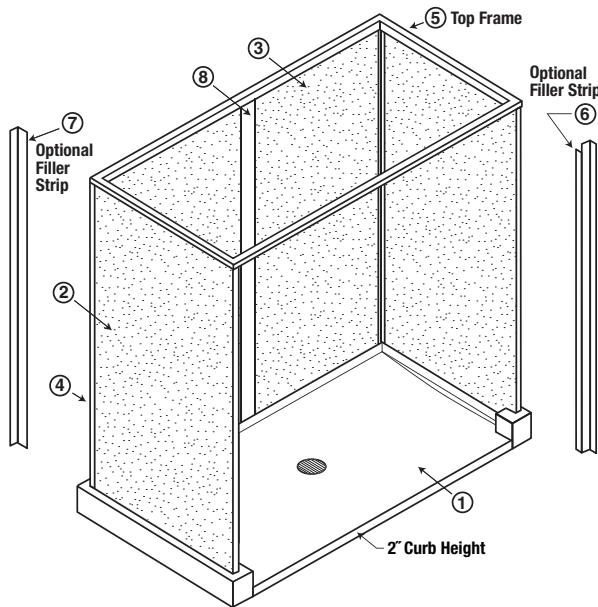

NOTE: Conforms to 2010 ADA Guidelines for Design (60x30")



STANDARD EQUIPMENT FOR FIELD INSTALLATION

KEY NO. QTY. DESCRIPTION

KEY NO.	QTY.	DESCRIPTION
1	1	65" X 33" BASE
2	2	30" X 77-3/16" PANEL
3	1	60" X 77-3/16" BACK PANEL
4	2	CORNER JOINT
5	1	TOP FRAME
—	1	ROD AND CURTAIN
—	1	PRESSURE BALANCED VALVE WITH STOPS
—	1	HAND HELD SHOWER HEAD WITH SWIVEL CONNECTOR, SUPPLY ELL, VACUUM BREAKER AND 69" C.P. FLEXIBLE BRASS HOSE
—	1	24" C.P. BRASS SLIDE BAR WITH ADJUSTABLE SHOWER HEAD MOUNTING BRACKET AND MOUNTING SCREWS.
—	2	HORIZONTAL STAINLESS STEEL GRAB BAR
8	1	CHANNEL BRACKET
—	1	RETRACTABLE HANDICAPPED SHOWER SEAT WITH STAINLESS STEEL FRAME

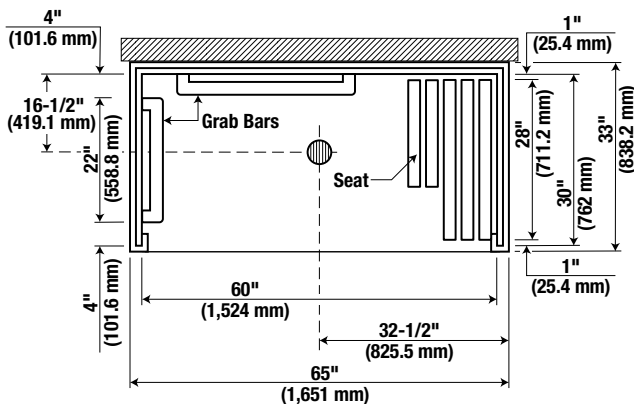
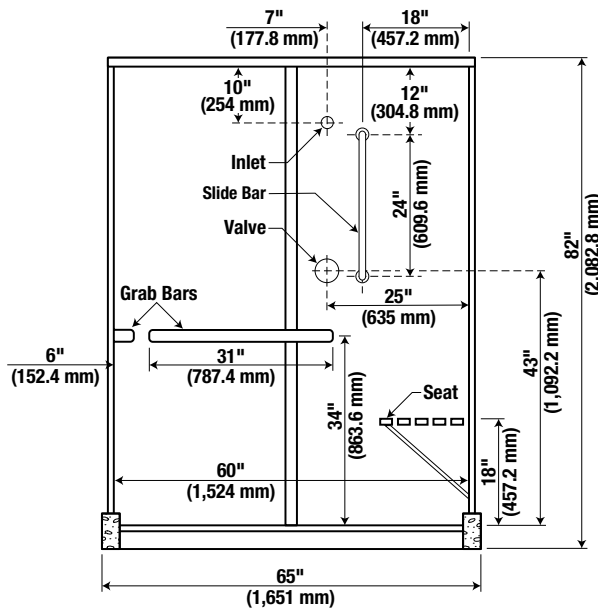

FOR CORRECT INSTALLATION:

1. ESTABLISH PROPER CLEARANCE BETWEEN SHOWER BASE AND WALLS.
2. SET SHOWER BASE ON MORTAR BED AND CAREFULLY LEVEL TO AVOID PROBLEMS OF UNEVEN SUB FLOOR.

OPTIONS

- FRONT FILLER STRIP (KEY NO. 6)
- FILLER STRIP (KEY NO. 7)
- FINISH:
 - POWDER COAT ON GALVANIZED STEEL
 - HIGH DENSITY POLYMER (H.D.P.)
 - STAINLESS STEEL
 - SOLID PHENOLIC CORE (S.P.C.)
- THERMOSTATIC VALVE
- TOP COVER
- TOP COVER WITH LIGHT
- VALVE BY OTHERS
- COLOR:
 - WHITE
 - OPTIONAL

WE SUGGEST A FLOOR DRAIN AT THE ENTRANCE TO THE WHEELCHAIR SHOWER FLOOR

NOTE:

1. For Barrier-Free installation Contractor shall provide recess for curb.
2. All dimensions subject to manufacturing variance of plus or minus 1/4" (6 MM).